







Mercedes-Benz

Sound 5

Operator's Manual

Symbols

-  Warning
 -  Possible vehicle damage
 -  Helpful hints or further information
 -  Instructions
 -  Continuation symbol
 -  Page reference
- Display Messages in the display

Vehicle Distributor

In the USA:

Mercedes-Benz USA, LLC
One Mercedes Drive
Montvale, NJ 07645-0350
www.mbusa.com

Customer Assistance Center:
1-877-762-8267

In Canada:

Mercedes-Benz Canada Inc.
98 Vanderhoof Avenue
Toronto, ON M4G 4C9
www.mercedes-benz.ca

Customer Relations Department:
1-800-387-0100

Mercedes-Benz USA, LLC and Mercedes-Benz Canada Inc. are Daimler companies.

Canada only:

Authorized Sprinter Dealer is defined as an authorized Mercedes-Benz Sprinter Dealer.

Welcome to Sound 5.

Please familiarize yourself with your Sound 5 radio and read this Operator's Manual before using it. This will help you to obtain the maximum pleasure from your system and to avoid endangering yourself and others.

The equipment or product description of your Sound 5 may vary, depending on:

- model
- order
- country specification
- availability

The manufacturer continuously updates its vehicles and equipment. We therefore reserve the right to make changes with regard to:

- design
- equipment
- technical features

Your nearest authorized Sprinter Dealer will be happy to assist you further if you have any other questions.

This manual is an integral part of the vehicle. Always keep this Operator's Manual in the vehicle. Pass it on to the new owner if you sell the vehicle.

We extend our best wishes for many miles of safe, pleasurable driving.

Index 4

Introduction 7

At a glance 9

Operation 13

Radio mode 19

CD mode 23

External audio source 31

- A**
- Adjusting** 15
 - Audio input 32
 - Balance 15
 - Bass 15
 - Fader 15
 - Mid-range 16
 - Sound 15, 18
 - Treble 15
 - Volume 14
 - Waveband 20
 - Album name**
 - Display 30
 - AM waveband** 20
 - Audible fast forward/rewind (CD)** 27
 - Audio input**
 - Setting up 32
 - Automatic switching** 16
 - AUX mode** 32
- B**
- Balance**
 - Adjusting 15
 - Bass**
 - Adjusting 15
- C**
- CD**
 - Controls 10
 - Ejecting 27
 - General information 24
 - Notes on handling 26
 - Playback 27
 - Playback options 29
 - Random function 29
 - Risk of injury 7, 24
 - Scan mode 28
 - Skip 27
 - Track repeat 29
 - CD changer** 32
 - CD mode**
 - Playback time display 30
 - Switching to 27
 - Changing folders**
 - MP3/WMA 28
 - Confirmation tone (BEEP)**
 - Adjusting the volume 17
 - Connecting**
 - External audio source 32
 - Controls**
 - CD 10
 - External audio source 32
 - Radio 10
 - Steering wheel with buttons 11, 17
- D**
- Displays** 30
 - Album name 30
 - Playback time 30
 - Total playback time 30
 - Tracks 30
- E**
- Ending**
 - Scan mode (CD) 28
 - Scan mode (radio) 22
 - Track repeat (CD) 29
 - External audio source**
 - Connecting 32
 - Controls 32
 - Switching to 32
- F**
- Fader**
 - Adjusting 15
 - Fast forward/rewind (CD)** 27
 - FM waveband** 20
- G**
- General information (CD)** 24

- I**
- ID3 tags**
 - see Track 30
 - Inserting a CD** 26
 - Interference** 8
- L**
- Linear** 16
- M**
- Manual mute** 16
 - Metadata**
 - see Track 30
 - Mid-range**
 - Adjusting 16
 - MP3/WMA**
 - Changing folders..... 28
 - Notes on operation..... 25
 - Playback options 29
 - Mute** 16
- O**
- Operating safety** 7
- P**
- Playback options** 29
 - Proper use** 8
- R**
- Radio**
 - Controls 10
 - Scan mode 21
 - Radio mode**
 - activates..... 20
 - Random function (CD)**..... 29
 - Random playback**
 - see Random function 29
 - Reception quality**..... 17
 - Repeat**
 - see Track repeat..... 29
 - Repeat album**..... 30
 - Risk of accident** 7
 - Risk of injury (CD)** 7, 24
- S**
- Scan mode**
 - CD..... 28
 - Radio..... 21
 - Selecting** 20
 - Station 20
 - Setting**
 - AM waveband 20
 - FM waveband 20
 - WB (Weather Band)..... 20
 - Skipping (CD)** 27
 - Sound**
 - Adjusting on the radio 15
 - Adjusting on the steering wheel . . . 18
 - Speed-dependent volume control**..... 14
 - Starting**
 - Scan mode (CD) 28
 - Scan mode (radio) 21
 - Station**
 - Saving using Autostore..... 22
 - Selecting..... 20, 21
 - Storing 22
 - Storing manually..... 22
 - Steering wheel with buttons** 11
 - Controls 17
 - Stereo**
 - Symbol 17
 - Storing**
 - Station 22
 - Switching**
 - Automatic..... 16
 - to an external audio source 32
 - to CD mode 27
 - Switching folders**
 - see Changing folders 28

| | |
|---|--------|
| Switching off | 14 |
| Manual mute | 16 |
| Random playback (CD) | 29 |
| Track repeat (CD) | 29 |
| Switching on | 14 |
| Manual mute | 16 |
| Radio mode | 20 |
| Random playback (CD) | 29 |
| Track repeat (CD) | 29, 30 |
| Switching over the display | 17 |
| Symbol | |
| Stereo | 17 |

T

| | |
|--------------------------------|--------|
| Total playback time | |
| Display | 30 |
| Track repeat (CD) | 29, 30 |
| Tracks | |
| Display | 30 |
| Treble | |
| Adjusting | 15 |

V

| | |
|--------------------------------|----|
| Volume | |
| Adjusting | 14 |
| Confirmation tone (BEEP) | 17 |

W

| | |
|--------------------------------|----|
| Waveband | |
| Setting | 20 |
| Weather Band (WB) | 20 |
| WMA | |
| see MP3/WMA | 25 |

Operator's Manual

Your vehicle may have some or all of the equipment described in this manual. Therefore, you may find explanations for optional equipment not installed in your vehicle. If you have any questions about operating particular equipment, any authorized Sprinter Dealer will be glad to demonstrate the proper procedures.

Optional equipment is also described in this manual, including operating instructions wherever necessary. Since they are special-order items, the descriptions and illustrations herein may vary slightly from the actual equipment of your vehicle.

If there are any equipment details that are not shown or described in this Operator's Manual, any authorized Sprinter Dealer will be glad to inform you of correct care and operating procedures. The Operator's Manual is an important document and should be kept with the vehicle.

Operating safety

Risk of accident

Always focus your attention on the traffic conditions. Only operate Sound 5 if traffic conditions permit you to do so. Operating Sound 5 while driving will distract you from the traffic situation and as a result you may lose control of your vehicle, thereby causing an accident.

Remember that even at a speed of 30 mph (50 km/h), your vehicle covers a distance of almost 44 feet (14 m) every second.

Risk of injury

The CD drive is a class 1 laser product. There is a risk of exposure to invisible laser radiation if you open the casing or if the casing is faulty or damaged.

Do not open the casing. The unit contains no parts on which you can carry out maintenance. For safety reasons, have any necessary maintenance work carried out by qualified aftersales technicians only.

Risk of accident and injury

Always have work on the vehicle carried out at a qualified specialist workshop. In particular, work relevant to safety or work on safety-related systems as well as maintenance work must be carried out at a qualified specialist workshop which has the necessary specialist knowledge and tools to carry out the work required.

We recommend that you use an authorized Sprinter Dealer for this purpose.

Risk of accident

If work on electronic equipment or systems (e.g. radio or CD drive) and/or software is carried out incorrectly, this or other equipment could stop functioning since the electronic systems are networked via interfaces. Tampering with electronic systems could cause malfunctions in systems which have not been modified. Such malfunctions can seriously compromise the vehicle's operating safety and your own safety as well.

We recommend that you have any service work on electronic components carried out at an authorized Sprinter Dealer.

i USA only:

This device complies with Part 15 of the FCC Rules.

Operation is subject to the following two conditions:

- (1) This device may not cause harmful interference, and
- (2) this device must accept any interference received, including interference that may cause undesired operation.

Any changes or modifications not expressly approved by the party responsible for compliance could void the user's authority to operate this equipment.

i Canada only:

This device complies with RSS-210 of Industry Canada.

Operation is subject to the following two conditions:

- (1) This device may not cause harmful interference, and
- (2) this device must accept any interference received, including interference that may cause undesired operation of the device.

Any changes or modifications not expressly approved by the party responsible for compliance could void the user's authority to operate this equipment.

Adherence to the relevant specifications for electromagnetic compatibility is therefore guaranteed for this device.

As a result, interference caused by your equipment in other electrical / electronic equipment and interference in your equipment caused by other electrical / electronic equipment is largely prevented.

! Portable electronic devices in the vehicle can severely impair the radio reception.

Proper use

Always observe the following when using the Sound 5 radio:

- the safety notes in this manual
- national road traffic regulations

Vehicle equipment
Controls
Steering wheel with buttons



Vehicle equipment

i This Operator’s Manual describes all features, standard or optional, potentially available for your vehicle at the time of purchase. Please be aware that your vehicle might not be equipped with all features described in this manual.

Controls

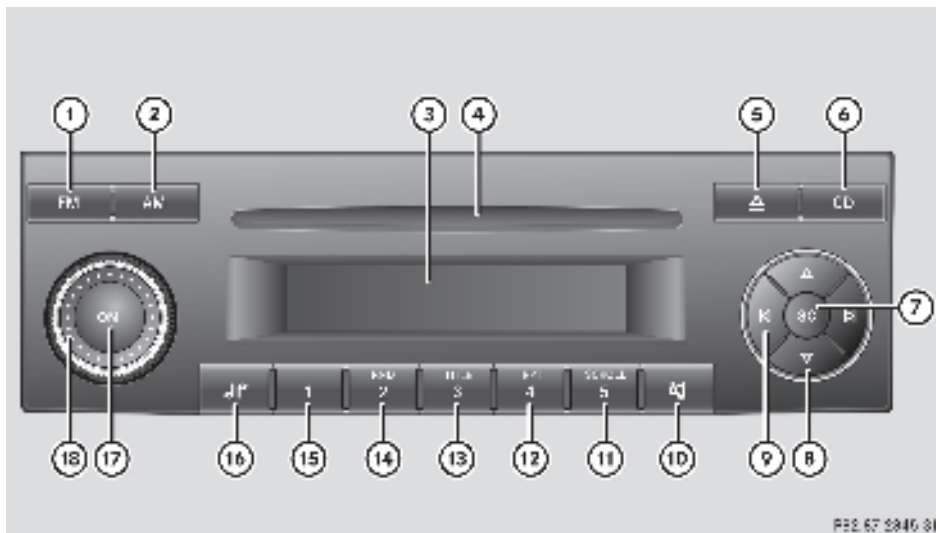

FIG. 67 2946 81

| | Function | Page |
|---|--|------|
| ① | Switches between FM wavebands | 20 |
| ② | Switches between AM and WB (Weather Band) waveband | 20 |
| ③ | Display | |
| ④ | Disc slot | 26 |
| ⑤ | CD eject button | 27 |
| ⑥ | Switches on CD or AUX mode | 27 |
| ⑦ | Radio mode: Starts scan mode | 21 |
| | CD mode: Starts scan mode | 28 |

| | Function | Page |
|---|---|------|
| ⑧ | Radio mode: Manual station tuning | 20 |
| | MP3 mode: Changes folders | 28 |
| ⑨ | Radio mode: Starts station search | 21 |
| | CD mode: Skip | |
| | Fast forward / rewind | 27 |
| ⑩ | Mute | 16 |
| ⑪ | Radio mode: Memory preset 5 | 21 |
| | CD mode: Stops title scrolling | 30 |

| | Function | Page |
|---|--|------|
| ⑫ | Radio mode: Memory preset 4 | 21 |
| | CD mode: Turns repeats on/off | 29 |
| ⑬ | Radio mode: Memory preset 3 | 21 |
| | CD mode: Displays the playback time | 30 |
| | MP3 mode: Displays album / track name / run time | 30 |
| ⑭ | Radio mode: Memory preset 2 | 21 |
| | CD mode: Random playback | 29 |
| ⑮ | Radio mode: Memory preset 1 | 21 |
| ⑯ | Calls up the Sound menu | 15 |
| ⑰ | On / off | 14 |
| ⑱ | Adjusts the volume | 14 |

Steering wheel with buttons

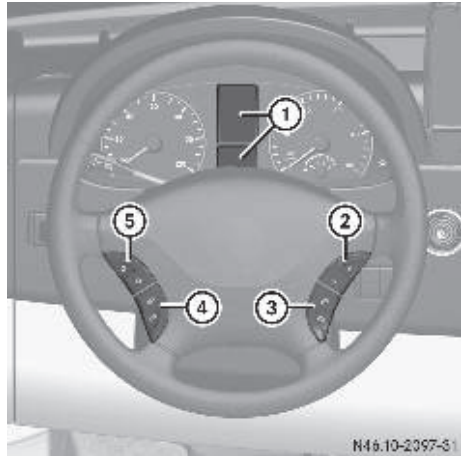

| | Function | Page |
|---|---|----------------|
| ① | Display | 17 |
| ② | Adjusts the volume: <input type="checkbox"/> + increases <input type="checkbox"/> - decreases Adjusts the sound settings: <input type="checkbox"/> + increases the value <input type="checkbox"/> - decreases the value | 14 18 |
| ③ | Telephone operation ¹ | |
| ④ | Changes the menu display: <input type="checkbox"/> forwards <input type="checkbox"/> backwards | 17 |
| ⑤ | Radio mode: <input type="checkbox"/> next station <input type="checkbox"/> previous station Selects a sound setting: <input type="checkbox"/> next sound setting <input type="checkbox"/> previous sound setting CD mode: <input type="checkbox"/> next track <input type="checkbox"/> previous track | 21 18 27 |

1. This function is not supported in vehicles equipped with Sound 5.

Vehicle equipment
Radio
Steering wheel with buttons

Vehicle equipment

- i** This Operator's Manual describes all features, standard or optional, potentially available for your vehicle at the time of purchase. Please be aware that your vehicle might not be equipped with all features described in this manual.

Radio

- i** The Sound 5 radio may be operated as follows:

- by using the controls on the Sound 5 radio itself
- by using the steering wheel buttons

This Operator's Manual describes both operation via the Sound 5 radio and also via the steering wheel buttons. Unless stated otherwise, all descriptions and illustrations refer to the Sound 5 radio.

Your Sound 5 radio features an acoustic confirmation tone. Operations carried out by pressing and holding down the buttons on the Sound 5 radio end with an acoustic signal (e.g. storing stations).

Switching on and off

Switching on

- ▶ Turn the key to position **1** or **2** in the ignition lock.

or

- ▶ Press the  button.

In both cases the radio returns to the operating mode set before the equipment was turned off.

- i** If key is not inserted in position **1** or **2** in the ignition lock, the radio automatically switches off again after around 60 minutes.

Switching off

- ▶ Turn the key to position **0** in the ignition lock and remove it.

or



- ▶ Press the  button.

Volume

- i** Radio, CD and AUX operating modes have their own volume setting.

When you set the volume, the radio saves the setting automatically for whichever operating mode is currently active.

Adjusting the volume

- ▶ Turn the  control knob on Sound 5.
- or
- ▶ Press the  or  button on the steering wheel.

The radio saves the volume settings when it is switched off.





- i** If the volume is above the maximum volume when switched off, it may be quieter when switched on again if the vehicle has been at a standstill for a long period of time.

Speed-dependent volume control

The Sound 5 radio controls the volume according to the speed of the vehicle.

Sound setting

Adjusting the sound setting

- ▶ Press the  button.
 - ▶ Turn the  control knob on Sound 5.
- or
- ▶ Press the  or  button on the steering wheel.

The display in the instrument cluster shows the current setting.

Balance and fader



Shared balance and fader settings apply to the radio, CD and AUX operating modes.

Setting the fader (volume distribution between front and rear)

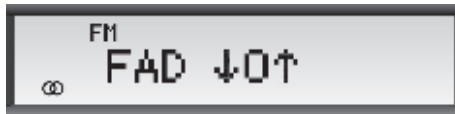
- ▶ Press the  button repeatedly until the Fader menu appears.
- The current setting will appear.



FRZ.86-9193.31



- ▶ Turn the  control knob.
- or
- ▶ Press the  or  button on the steering wheel.
- The setting will change. The new setting is saved as soon as the Fader menu disappears.

Setting the balance (volume distribution between left and right)

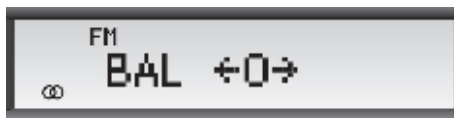
- ▶ Press the  button repeatedly until the Balance menu appears.
- The current setting will appear.



FRZ.86-9193.31

- ▶ Turn the  control knob.
- or
- ▶ Press the  or  button on the steering wheel.
- The setting will change. The new setting is saved as soon as the Balance menu disappears.

Bass, treble and mid-range

-  Different bass / treble settings are possible for all operating modes.



When you set the bass or treble, the radio saves the setting automatically for whichever operating mode is currently active.

Adjusting the bass

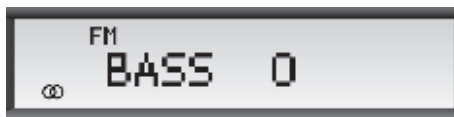
- ▶ Press the  button repeatedly until the Bass menu appears.
- The current setting will appear.



FRZ.86-9193.31

- ▶ Turn the  control knob.
- or
- ▶ Press the  or  button on the steering wheel.
- The setting will change. The setting is saved as soon as the Bass menu disappears.

Adjusting the treble

- ▶ Press the  button repeatedly until the Treble menu appears.
- The current setting will appear.



PB2.86-9184-31

- ▶ Turn the control knob.

or

- ▶ Press the or button on the steering wheel.

The setting will change. The new setting is saved as soon as the Treble menu disappears.

Adjusting the mid-range

- ▶ Press the button repeatedly until the Mid-range menu appears.

The current setting will appear.

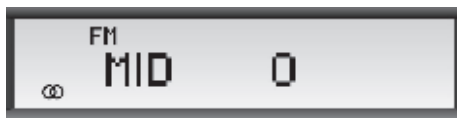

PB2.87-2849-21

- ▶ Turn the control knob.

or

- ▶ Press the or button on the steering wheel.

The setting will change. The new setting is saved as soon as the Mid-range menu disappears.

Linear

This function adjusts the following settings to medium:

- volume
- fader
- balance
- bass, treble, and mid-range
- Volume of the confirmation tone (BEEP)
- ▶ Press and hold the button until you hear a tone.



PB2.86-9188-31

The settings are reset to medium.

Mute

- ▶ **To mute:** briefly press the button.



PB2.86-9220-31

The radio switches to mute. In CD mode, the CD stops.

- ▶ **To deactivate:** briefly press the button.

or

- ▶ Turn the control knob.

You will hear the audio source you were listening to before mute was activated.

Automatic switching



PB2.86-9221-31

The radio automatically switches if:

- a system such as a hands-free device or a navigation system (Personal Navigation Device / PND) is installed
- and if the system activates the mute function via a connection line to the radio.

The radio switches the audio output according to the following priorities when in radio or CD mode:

1. Telephone (hands-free system)
2. Navigation device (PND)



In this operating mode, you can only switch off and adjust the volume of the Sound 5 radio.

Adjusting the volume of the confirmation tone

- ▶ Press the  button repeatedly until the BEEP menu appears.
The current setting will appear.



PB2.B7 2850 31

- ▶ Turn the  control knob.
or
- ▶ Press the  or  button on the steering wheel.
The setting will change.
The new setting is saved as soon as the BEEP menu disappears.

Reception quality





PB2.B7 2848 31

If a radio station is broadcast in stereo and the reception quality is sufficient, stereo symbol ① appears in the bottom left of the display.

Steering wheel with buttons

The instrument cluster display must be switched to the radio or CD function to allow operation using the steering wheel buttons.

Switching over the display

- ▶ Press the  or  button on the steering wheel repeatedly until the desired menu appears.

The following displays are shown as examples.

Radio mode display

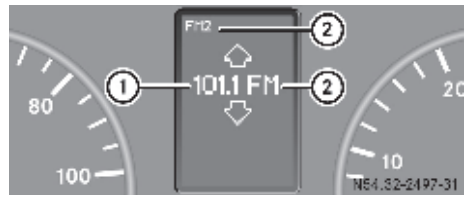

- ① Receiving frequency or station ID (if one is being broadcast)
- ② Waveband with memory location number of station in station memory (if stored)

CD mode display







- ① CD mode
- ② Current track

Adjusting the sound setting



Operation

① Sound setting example: Bass menu

- ▶ Briefly press the  button on the radio.
- ▶ On the steering wheel, press the  or  button repeatedly until the desired Sound menu appears in the instrument cluster display.
- ▶ On the steering wheel, press the  or  button to set the desired value.

The new setting is saved as soon as the Sound menu disappears.

Vehicle equipment
Radio mode

Vehicle equipment

- i** This Operator's Manual describes all features, standard or optional, potentially available for your vehicle at the time of purchase. Please be aware that your vehicle might not be equipped with all features described in this manual.

Radio mode

Risk of accident

Please devote your attention first and foremost to the traffic situation you are in.

Before your journey, please familiarize yourself with the radio functions. Only use the Sound 5 radio when road and traffic conditions permit you to do so. Otherwise you could be involved in an accident in which you or others could be injured.

Switching to radio mode

You can use the **FM** and **AM** buttons to call up the following wavebands:

- FM: station memory 1–5
- FM: station memory 6–10
- FM-AS: Autostore
- AM
- WB (Weather Band)

The waveband is displayed first and then the station last selected on the chosen waveband.

Setting the waveband

Setting the FM waveband

- i** FM waveband: 87.5–108 MHz
- ▶ Press the **FM** button repeatedly until one of the FM wavebands appears (FM 1–5, FM 6–10 or FM-AS).

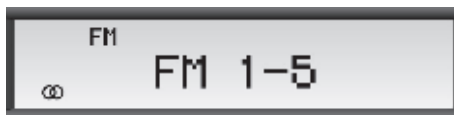

The radio selects the last station you were listening to that was set on one of the three FM wavebands.

Setting the AM waveband

- i** AM waveband: 530–1,710 kHz
- ▶ Press the **AM** button until AM appears. The radio selects the last station you were listening to.

Setting the Weather Band (WB)

- ▶ Press the **AM** button until WB appears. Weather Band will automatically tune to the strongest station in the area.

Selecting a station

Stations may be selected in the following ways:

- selecting a station using station search
- selecting a station using manual search
- selecting a station using station presets

Selecting using station search

Using the Sound 5 radio

- ▶ Set the desired waveband (▷ page 20).
- ▶ Press the  button.

The station search starts in ascending order.

or

- ▶ Press the  button.

The station search starts in descending order.

In both cases, the station search stops at the next station with adequate reception.

Using the steering wheel buttons

i You can switch between station selection via memory presets and station selection via frequency on the instrument cluster. For information on how to do this, see the vehicle Operator's Manual.

- ▶ Set the desired waveband (▷ page 20).
- ▶ Switch the display to the Audio menu (▷ page 17).
- ▶ Press the  button.

The station search starts in ascending order.

or



- ▶ Press the  button.

The station search starts in descending order.



Depending on the instrument cluster setting, the station search stops at the next station which can be received, either preset in the memory or on the waveband.

Tuning in manually

i This function is not available for Weather Band (WB).

- ▶ Set the desired waveband (▷ page 20).
- ▶ Briefly press the  or  button on the radio.

The waveband is searched in the frequency steps stated above.

- ▶ Press and hold the  or  button on the radio.



The search does not stop at the frequency steps stated above.

Selecting using the station presets



You can store 5 stations in the AM waveband and 5 stations in the Weather Band (WB).

For the FM wavebands, a total of 10 fixed stations and 5 Autostore memory presets can be used.



Using Sound 5

- ▶ Set the desired waveband (▷ page 20).
- ▶ Press one of the buttons from  to .

The radio selects the stored station.

i With the FM 6–10 range, memory presets 6–10 are also set using buttons  to . Memory preset location 10 appears in the display as FM0.

Using the steering wheel buttons

- ▶ Set the desired waveband (▷ page 20).
- ▶ Switch the display to the Audio menu (▷ page 17).
- ▶ Press the  or  button.

The stored station is selected.

You can select presets 1–10 using the steering wheel buttons if:

- the Sound 5 radio is either in the FM 1–5 or FM 6–10 preset group and
- the display is set to "Select station from memory" (▷ page 17). Information on how to set the display can be found in the vehicle Operator's Manual.

Scan mode

- Scan mode plays each station with adequate reception for around 8 seconds.
- After it has run through the stations twice, the scan stops automatically at the station you were listening to before the scan was started.

Starting scan mode

- ▶ Switch to the desired waveband (▷ page 20).
- ▶ Press the **SC** button.

The station search starts.

Ending scan mode

- ▶ Press the **SC** button again.
The station search stops.

Storing a station

You can store stations in the FM, AM and WB wavebands manually or using Autostore.

Storing manually

Five memory presets are available for each waveband.

- ▶ Set the station to be stored (▷ page 20).
- ▶ Press and hold a button between **1** and **5** until you hear a tone.

The station will be saved at the button you have pressed.

Saving using Autostore

- i** Saving using Autostore is only possible in the FM-AS waveband.

The radio fills the five memory presets in the FM-AS waveband with stations in order of reception quality.

If no stations are available, the radio fills all Autostore locations with the lowest frequency.

- ▶ Press the **FM** button repeatedly until the FM-AS waveband appears.



F87.86-9189-31

- ▶ Press and hold the **SC** button until you hear a tone and the Autostore station search starts.



F87.86-9193-31

When AS-Seek disappears, saving is complete.

Vehicle equipment
General information
CD mode

CD mode



Vehicle equipment

- i** This Operator's Manual describes all features, standard or optional, potentially available for your vehicle at the time of purchase. Please be aware that your vehicle might not be equipped with all features described in this manual.

General information

Risk of injury

The CD drive is a class 1 laser product. There is a risk of exposure to invisible laser radiation if you open the casing or if the casing is faulty or damaged.

Do not open the casing. The unit contains no parts on which you can carry out maintenance. For safety reasons, have any necessary maintenance work carried out by qualified aftersales technicians only.

Risk of accident

In order to avoid distraction which could lead to an accident, the driver should insert or eject CDs with the vehicle at a standstill and operate the Sound 5 radio only if permitted by road, weather and traffic conditions.

Bear in mind that at a speed of just 30 mph (50 km/h), your vehicle is covering a distance of 44 feet (14 m) every second.

- i** Explanation of terminology:
 - The terms "track" and "file" are used in this manual to describe a single piece of music on a CD. "Track" refers to pieces of music on audio CDs or on MP3/WMA CDs. "File" is used for MP3/WMA CDs only.
 - The term "folder" is used to describe file directories on MP3/WMA CDs which contain MP3/WMA tracks.

- i** In some cases, the Sound 5 radio may not be able to play audio CDs with copy protection.

There may be playback problems when playing copied CDs.

- i** There are a large variety of discs, disc-writing software and writers available. This variety means that there is no guarantee that the Sound 5 radio will be able to play discs that you have copied yourself.

There may be playback problems if you play CDs that you have copied yourself with a storage capacity of more than 700 MB. CDs of this type do not conform to currently applicable standards.

- !** Do not affix stickers or labels to the discs. They could peel off and damage the drive. Such damage is not covered by the New Vehicle Limited Warranty.

- !** The drive is designed to hold discs which comply with the EN 60908 standard. Therefore, you can only use discs with a maximum thickness of 1.3 mm.

If you insert thicker discs, e.g. those that contain data on both sides (DVD on one side and audio data on the other), they cannot be ejected and they can damage the CD drive.

Do not use discs with a diameter of 8 cm, even with an adapter, as this can damage the drive. Such damage is not covered by the New Vehicle Limited Warranty.

Only use round discs with a diameter of 12 cm.

Notes on MP3 /WMA operation

The following points should be taken into account when using MP3 and WMA CDs:

- Only MP3 /WMA files (tracks) that have been written on a CD using ISO 9660 / Joliet file system can be played by the system.
- In particular, read errors may occasionally occur with discs you have copied yourself, even if the disc can generally be read correctly.
- Display of album and track name is limited to a maximum of 31 characters (depending on which character set is used).
- This equipment can play both write-once CDs (CD-R) and rewriteable CDs (CD-RW).
- Multisession CDs should be finalized to prevent playback problems.
- Multi-session CDs containing both audio tracks and MP3 /WMA tracks (mixed mode) are handled according to what is contained in the first session. If the first session contains audio tracks, the CD is treated as an audio CD. In such cases, any data stored in the second session cannot be played. Accordingly, only MP3 /WMA tracks may be played back if this is what is contained in the first session.
- The maximum number of folders per CD is 255. The maximum total number of folders and tracks (files) on a CD is 999.
- When moving between folders and tracks, these are displayed and selected linearly. Any existing hierarchical (nested) folder structure is handled as a linear sequence.

Information regarding MP3 files

- To display the track and album name, you need to add the corresponding data (ID3 tags) to the MP3 file before writing the CD.

- We recommend a constant bit rate of at least 160 kbit / sec for the compression of MP3 data. With variable bit rates, the display of the elapsed playback time may differ from the time actually elapsed.
- The file extension for MP3 files must be "mp3" and must be separated from the file name by a period. If any other file extension is used, this will not be recognized by the equipment.

Information regarding WMA files

- To display the track and album name, you need to add the corresponding metadata to the WMA file.
- The file extension for WMA files must be "wma" and must be separated from the file name by a period. If any other file extension is used, this will not be recognized by the equipment.

i A number of factors influence whether or not a WMA file can be played, including:

- sampling rate
- bit rate
- encoding process
- software used for the creation of the WMA files
- writing software
- other settings (e.g. copy protection, Digital Rights Management, advanced audio format settings)

To create WMA files, use only current standard software, a sampling rate of 44.1 kHz and bit rates between 16 and 320 kbit / s. Do not use other settings, such as lossless coding, surround sound, DRM, copy protection, etc.

Do not use compilations that contain WMA files with other settings as this may render the CD unplayable even if only some files on the CD do not fulfill the required standards.

Notes on handling discs

- Handle discs carefully to prevent playback problems.
- Avoid getting scratches, fingerprints and dust on discs.
- Do not affix stickers to the discs.
- To label discs, only use a pen designed for this purpose.
- Clean discs from time to time with a conventional cleaning cloth. Do not wipe them with a circular motion, but only in straight lines from the center outwards.
- Place discs back in their cases after use.
- Protect discs from heat and direct sunlight.

CD mode

Switching to CD mode

- ▶ Insert a CD.
- or
- ▶ Press the  button.

Inserting a CD

Risk of accident

In order to avoid distraction which could lead to an accident, the driver should insert or eject CDs with the vehicle at a standstill and operate the Sound 5 radio only if permitted by road, weather and traffic conditions.

Bear in mind that at a speed of just 30 mph (50 km/h), your vehicle is covering a distance of 44 feet (14 m) every second.

i In some cases, the system may not be able to play audio CDs with copy protection.

- ▶ Insert the CD into the disc slot with the printed side upwards.

The CD is drawn automatically into the slot, and playback of the first track starts.

i If you insert the CD into the slot when the unit is switched off, the device will automatically switch on.

The length of time required to read the data (LOADING) depends on various factors (type of media, number of titles, whether copy-protected, etc.) and may take longer in some cases.

Display with audio CD:

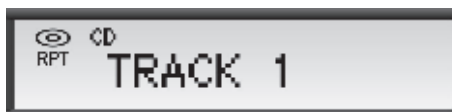

F87.86-9199-31

Display with MP3/WMA CD:

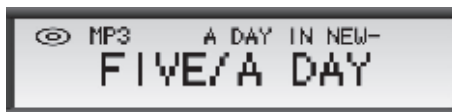

F87.86-9705-31

Initially, the title number is displayed briefly. Then, the first ten characters of the track name are shown.

i To display the full track name, press the  button. The track name only appears if it was added when the CD was created (ID3 tags / metadata). Otherwise, only the file name will be shown.

Ejecting the CD

Risk of accident

In order to avoid distraction which could lead to an accident, the driver should insert or eject CDs with the vehicle at a standstill and operate the Sound 5 radio only if permitted by road, weather and traffic conditions.

Bear in mind that at a speed of just 30 mph (50 km/h), your vehicle is covering a distance of 44 feet (14 m) every second.

- ▶ Press the  button.
The CD is ejected.
- ▶ Take the CD out of the slot.
If the CD is not removed from the disc slot within 10 seconds, the drive draws in the CD again for safety reasons.

CD playback

Switching to CD mode

- ▶ Press the  button once or twice.
CD playback begins at the point last listened to.

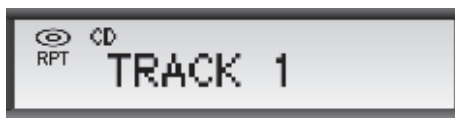

F87.86-9199-31

If no CD is inserted, the NO CD message appears for a short time.

The device jumps to the last sound source played.



Skipping forwards / backwards

Operation of this function is identical for audio CDs and MP3/WMA CDs.

- Skip forwards:
The next track is played.
- Skip back:
The current track restarts if it has been playing for longer than approximately 10 seconds. If it has been playing for less time, the previous track is played.



Skipping tracks using the controls on the Sound 5 radio

In CD mode, with an audio CD or MP3/WMA CD inserted:

- ▶ Press the  button to skip forward.
You will hear the next track.
- or
- ▶ Press the  button to skip back.
You hear the previous track or the start of the current track again.



Skipping tracks using the steering wheel buttons

In CD mode, with an audio CD or MP3/WMA CD inserted:

- ▶ Switch the display in the instrument cluster to the audio display (▷ page 17).
 - ▶ Press the  button to skip forward.
You hear the next track.
- or
- ▶ Press the  button to skip back.
You hear the previous track.

Audible fast forward / fast rewind

In CD mode, with an audio CD or MP3/WMA CD inserted:

- ▶ Press and hold the  button for fast forward.
- or
- ▶ Press and hold the  button for fast rewind.

Display with audio CD inserted:

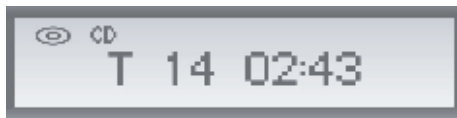

P82.86-9207-31

Display with MP3/WMA CD inserted:

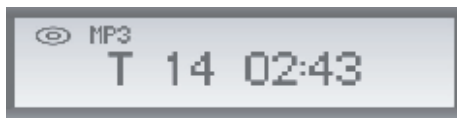

P82.86-9211-31

After the button is released, playback is continued at the current position. The remaining playback time for the current track is displayed for a further 8 seconds.

Scan mode

Scan mode plays each track on the current CD for approximately 10 seconds.

It ends automatically at the track you were listening to before you started the scan. You can also end the scan manually.

Operation of this function is identical for audio CDs and MP3/WMA CDs.

Starting scan mode

In CD mode, with an audio CD or MP3/WMA CD inserted:

- ▶ Press the **SC** button during CD playback.

With audio CD inserted:



P82.86-9217-31

Display with MP3/WMA CD inserted:



P82.86-9203-31

The track number chosen is displayed.

Ending scan mode



- ▶ Press the **SC** button.

The track you are currently listening to remains set.

Changing folders

This function is only available for MP3/WMA CDs.

In CD mode with MP3/WMA CD inserted:

- ▶ Press the  button to skip forward.
- or
- ▶ Press the  button to skip back.

The next or previous folder is selected.

Each time the folder is changed, the first ten letters of the folder name briefly appear on the display:



P82.86-9205-31

- i** To display the entire folder name, press button .

If a folder contains no WMA or MP3 tracks, that folder is not displayed.

Once selection of a folder is complete, the display switches back to the track name.

When moving between folders and tracks, these are displayed and selected linearly. Any existing hierarchical (nested) folder structure is handled as a linear sequence.

The ROOT folder¹ is displayed as \ROOT if it contains MP3 or WMA files.

1. The CD's top directory level, set up automatically by the burn software during writing.

Setting playback options

Random function (random playback)

You hear the tracks on the current CD in random order (e.g. 3, 8, 5, etc.). If you change the CD, random playback ends.

Switching on random playback

In CD mode, with an audio CD or MP3/WMA CD inserted:

- ▶ Press button **2**.
RANDOM appears briefly and the display then changes.

With audio CD inserted:

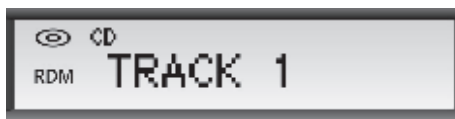

P82.86-9201-31

With MP3/WMA CD inserted:



P82.86-9217-31

Random playback of all albums

This function is only available for MP3/WMA CDs. The tracks of all albums are played in random order.

- ▶ Press button **2** twice.
RANDOM appears briefly and the display then changes.



P82.86-9216-31

Switching off random playback

- ▶ Press button **2** again.

Track repeat

You hear the current track repeatedly until you switch off the function, change the CD, or change the audio source.

Switching on repeat

In CD mode, with an audio CD or MP3/WMA CD inserted:

- ▶ Press button **4**.
REPEAT appears briefly and the display then changes.

With audio CD inserted:



P82.86-9199-31

With MP3/WMA CD inserted:



P82.86-9210-31

Switching off track repeat

- ▶ Press button **4** again.

Repeat album

This function is only available for MP3/WMA CDs.

You hear the current album repeatedly until you switch off the function, change the CD, or change the album.

Switching on album repeat

With MP3/WMA CD inserted:

- ▶ Press button **4** twice.
REPEAT appears briefly and the display then changes.



Switching off album repeat

- ▶ Press button **4** again.

Displaying playback time

With audio CD inserted:

- ▶ Press button **3**.

With audio CD inserted:

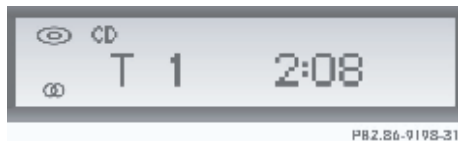

- i** Press button **3**. If an MP3/WMA CD is inserted, the album and track name are shown if this information was added when the CD was created (ID3 tags/metadata).

Displaying the number of CD tracks and total playback time

With audio CD inserted:

- ▶ Press button **3** twice.

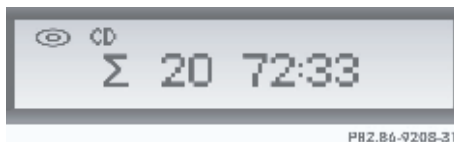

Displaying album and track name

With MP3/WMA CD inserted:

- ▶ Press button **3**.



Displaying the album and track name (ID3 tags/metadata)

With MP3/WMA CD inserted:

- ▶ Press button **3** repeatedly.
The album and track name scroll across the display from right to left.
If the album and track name are not present as ID3 tags, the file name is shown.
- ▶ **To cancel the display:** press button **5**.

Vehicle equipment
External audio source

Vehicle equipment

i This Operator's Manual describes all features, standard or optional, potentially available for your vehicle at the time of purchase. Please be aware that your vehicle might not be equipped with all features described in this manual.

External audio source

You can connect an external audio source (AUX) to the Sound 5 radio. The jack needed can be found to the side behind the instrument cluster.

i You cannot connect an external CD changer.

For more information on connections, consult a qualified specialist workshop or an authorized Sprinter Dealer.

Risk of accident

Operating an external audio source while the vehicle is in motion will distract you. You may not notice changing road and /or traffic conditions, which may cause an accident.

Bear in mind that at a speed of just 30 mph (50 km/h), your vehicle is covering a distance of 44 feet (14 m) every second.

For your safety and the safety of others, pull over to a safe location and stop before operating an external audio source.

Setting up the audio input

Depending on the device you want to connect, the audio input must be set up appropriately.

This set-up can be carried out at a qualified specialist workshop or an authorized Sprinter Dealer.

Possible settings are:

- audio input is switched off. Playback of an external audio source is not possible
- audio input is set to the mode for an external audio source

Operating External Devices

Switching to an external audio source (AUX)

Risk of accident

Due to the different volumes of the external audio sources, system messages of the vehicle may be much louder. You may need to disable these system messages or adjust the volume of these messages manually.

- i** You can only switch to AUX mode if the audio input is set appropriately.
- ▶ Press the  button repeatedly until the following display appears:



F87.85-9223.31

Operating functions

You can control the following external audio source functions via the Sound 5 radio:

- volume adjustment
- sound settings

Operation is the same as for other audio sources (▶ page 14).

Internet

Further information about Mercedes-Benz vehicles can be found on the following website:

www.mercedes-benz.com

Editorial office

You are welcome to forward any queries or suggestions you may have regarding this manual to the technical documentation team at the address mentioned on the inside of the front cover.

© Mercedes-Benz USA, LLC

© Mercedes-Benz Canada Inc.

Mercedes-Benz USA, LLC and Mercedes-Benz Canada Inc. are Daimler companies.

Not to be reprinted, translated or otherwise reproduced, in whole or in part, without written permission.

Printed in U.S.A

Press date: November 2, 2009



0 0 5 5 8 4 6 1 8 1

Order no. 6462 2618 13 Part no. 005 584 61 81 Edition A 2010